

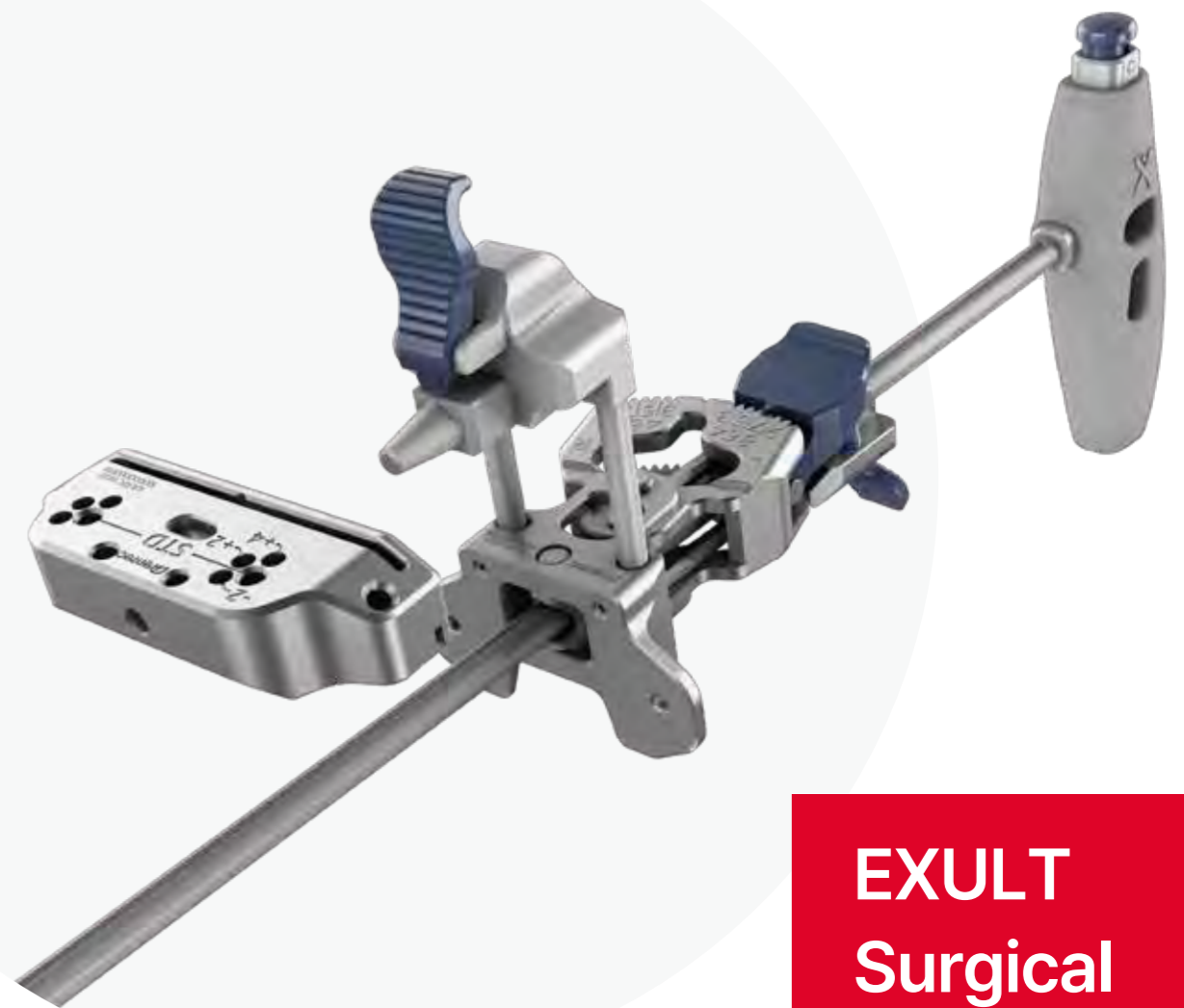

# EXULT

Total Knee System



**EXULT**  
**Surgical**  
**Technique**



33-2, Banpo-daero 20-gil, Seocho-gu, Seoul, Republic of Korea  
12, Yeongsanhong 1-gil, Ipjang-myeon, Seobuk-gu, Cheonan-si, Chungcheongnam-do, Korea

**T** +82 02-6937-4922  
**E** [corentec@corentec.com](mailto:corentec@corentec.com)

## Instrument Features

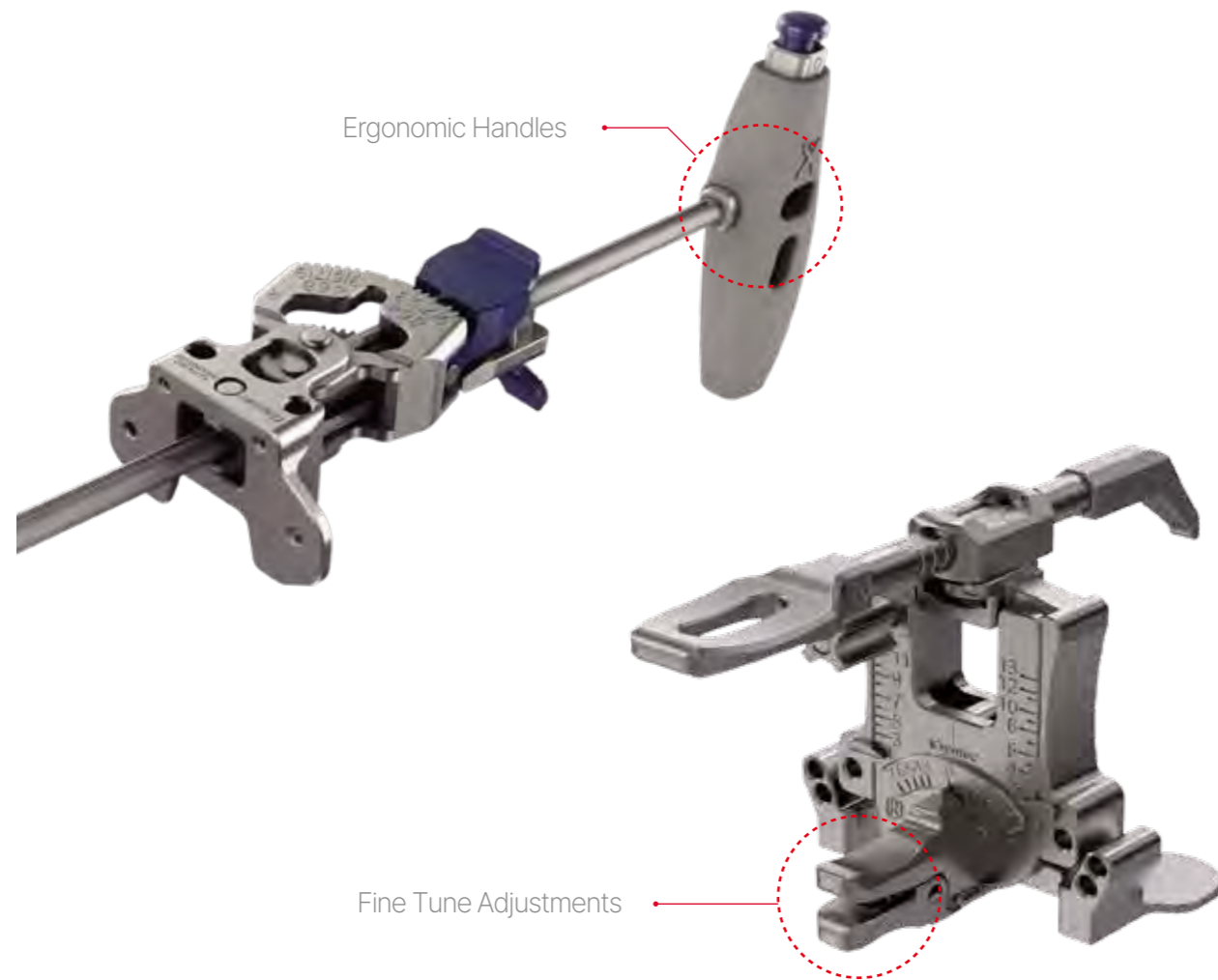

## Surgical Preparation

### INTRODUCTION

The Exult Knee System offers an anatomically featured shape for a cruciate retaining (CR), a posterior stabilized(PS), a ultra congruent(UC) and a constrained posterior stabilized(CPS) knee within a single system to reproduce better natural knee motion and increase implant longevity.

Each surgeon is responsible for determining the appropriate device and technique for each patient.

Exult Instrumentation is designed to address patient variables and individual surgeon preferences.

This surgical protocol depicts tibial preparation after femoral preparation.

This order may be changed to address patient indications or surgeon preferences.

### PREOPERATIVE PLANNING

The angle between the anatomic axis (center of the knee-intramedullary canal) and the mechanical axis (Center of the femoral head center of the knee) defines the valgus angle.

These angles should be determined for both knees.

The angle must be determined before performing the distal femoral resection by comparison with the healthy joint to restore this valgus angle in the diseased joint.

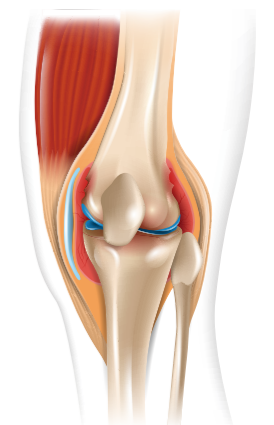

# 1. Femoral Preparation

**Figure 1** Drill the Intramedullary canal using the Twist Drill. Begin drilling approximately 10mm anterior to the femoral attachment of the Posterior Cruciate Ligament and slightly medial to the midline of the distal femur.

**Figure 2** Illustrates the combination of the instruments and instruments used for Femoral Alignment. The below instruments are located in the Femur Intramedullary canal.

**Figure 3** Adjust the angle of the Femoral Alignment Guide to set the valgus angle of the femur cut. The Femoral Alignment Guide allows for adjustment of the varus and valgus angles (0–9 degrees) by pressing the knob.

**Figure 4** Insert the IM Rod into the Modular T-handle and femoral Alignment Guide.

Figure 1



Figure 3



Figure 2

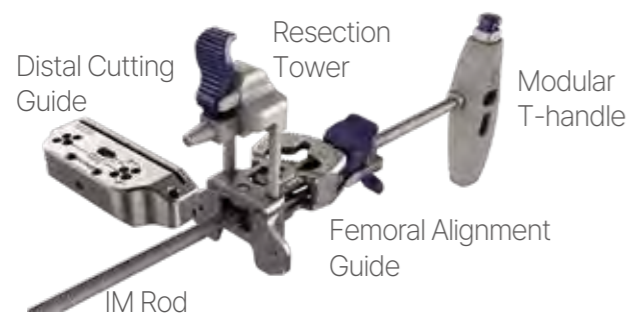

Figure 4



Figure 5



Figure 8



Figure 6



Figure 9



Figure 7



Figure 10



**Figure 5** Insert the Resection Tower into the Femoral Alignment Guide.

**Figure 6** Press and hold the Resection Tower button and insert the Distal Cutting Guide.

**Figure 7** Secure the Distal Cutting Guide with the button.

**Figure 8** Insert the Femoral Alignment Instrument into the Femur Intramedullary canal. Ensure that the Femoral Alignment Guide is in contact with the Distal Femur.

### Tip

**Figure 9,10**

Femoral Alignment Guide can move backward if not secured to Femur. Make sure Femoral Alignment Guide is in direct contact with Femoral Condyles.

## 1. Femoral Preparation



Figure 11

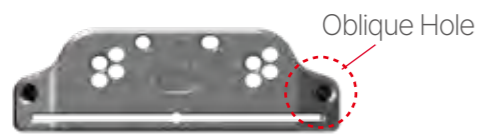

Figure 12

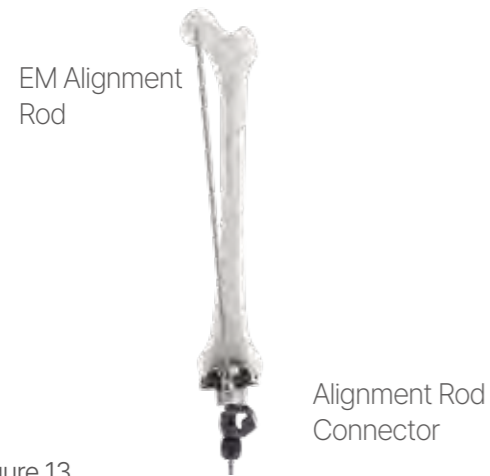

Figure 13

**Figure 11** Insert the headless pin through the pin hole marked with STD in the Distal Cutting Guide.

**Figure 13** Insert the Alignment Rod Connector and EM Alignment Rod into the desired alignment hole at the top of the Distal Cutting Guide. This confirms the EM Valgus Alignment.

### Tip

**Figure 12** The Distal Cutting Guide can be shifted +2 mm, +4 mm, or -2 mm. The thickness of the distal cutting guide can be adjusted according to the position where the headless pin is inserted. The distal cutting guide can be completely fixed by inserting a headless pin into the oblique holes on the mediolateral side.

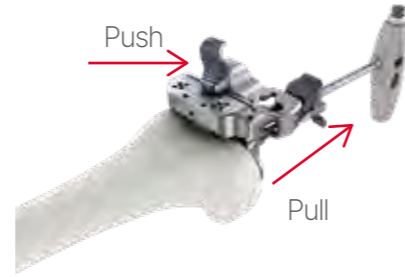

Figure 14



Figure 15

**Figure 14** Push the button on the Femoral Alignment Guide to disengage the Femoral Alignment Instrument before pulling the handle away from the Femoral Alignment Guide.

**Figure 15** Resect the distal femur with an oscillating saw blade through the cut slot in the distal cutting guide.

### Tip

A saw blade thickness of 1.27mm is recommended for all Exult resection guides. The Distal Cutting Guide is designed to resect 8.5mm of bone from the distal femur.

## 2. Tibial Preparation



Figure 16

### Figure 16

The Tibial Tower has four adjustment parts.

Combine the Proximal Tibial Rod Assembly and the Distal Tibial Rod Assembly.



Figure 17

**Figure 17** Assemble the Tibial Cutting Guide to the top of the Proximal Tibial Rod Assembly.

### TIP

The Knob at the top of the Proximal Tibial Rod Assembly is used to engage and disengage the Tibial Cutting Guide. **Figure 17** show Unlock, Lock status mechanism.

## 2. Tibial Preparation

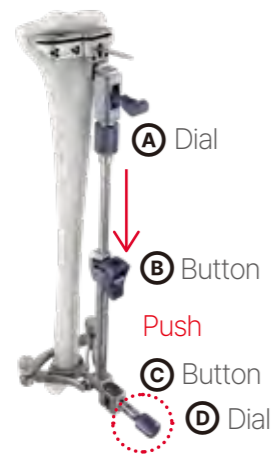

Figure 18

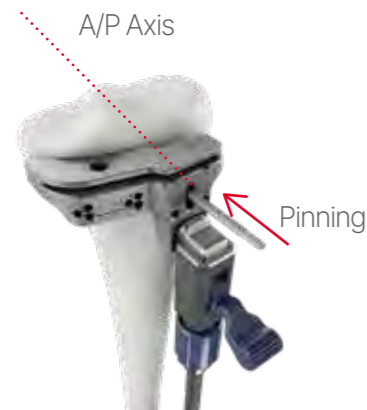

Figure 19

**Figure 18** Assemble the Ankle Clamp to the Distal Tibial Rod Assembly, position the Ankle Clamp directly above the malleoli with the knee bent.

Push the ©button to adjust the A/P, turn the ©dial to adjust the M/L, and fix the ankle clamp to the ankle.

Push the ©button to adjust the height of the Proximal Tibial Rod Assembly.

Turn the ©dial to fine-tune the height. The rotation of  $\frac{1}{2}$  is equal to 1 mm.

**Figure 19** It can be fixed arbitrarily using the long hole of the Tibial Cutting Guide and can be adjusted in a fixed state.



Figure 20

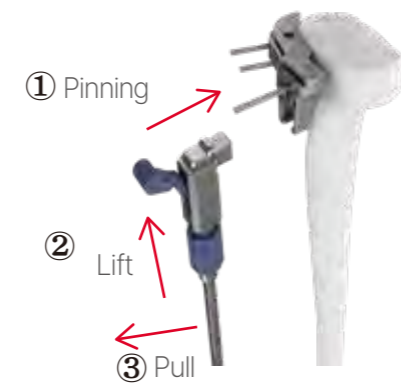

Figure 21

**Figure 20** Determine the level of the tibial cut with the Tibial Stylus (2 or 10 mm). Assemble the footplate of the Tibial Stylus in the Cutting Slot of the Tibial Cutting Guide, and check the resection level and slope using the Angel Wing.

**Figure 21** Insert the headless pin into the "0" hole in the Tibial Cutting Guide. Lift the lever on the Proximal Tibial Rod Assembly to disengage it from the Tibial Cutting Guide.

### TIP

The Tibial Cutting Guide can be moved by +2mm and +4mm.

Figure 23 Locking pin holes allow for tighter fixation.

## 2. Tibial Preparation



Figure 22



Figure 23

Figure 24

**Figure 22** Insert the Alignment Rod Connector with the EM Alignment Rod into the hole in the Tibial Cutting Guide Cutting Slot.

Use this to verify the Varus/Valgus alignment and the posterior slope.

**Figure 23** The pin can be inserted into the locking hole for stronger fixation.

**Figure 24** Resect the Proximal Tibia using the Oscillating saw blade through the cut slot of the Tibial Cutting Guide.

## 3. Extension Gap Assessment



Figure 25

**Figure 25** The gap gauge can confirm the extension gap between the femur with distal resection and tibia with proximal resection.

Gap Gauge can be used by attaching the Gap Plate.

## 4. Femoral Sizing and AP Resection

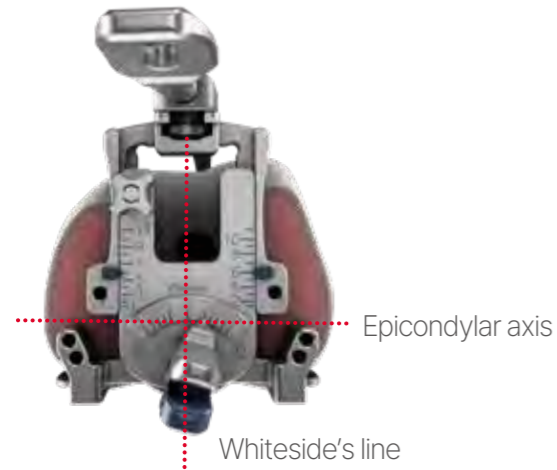

Figure 26



Figure 28

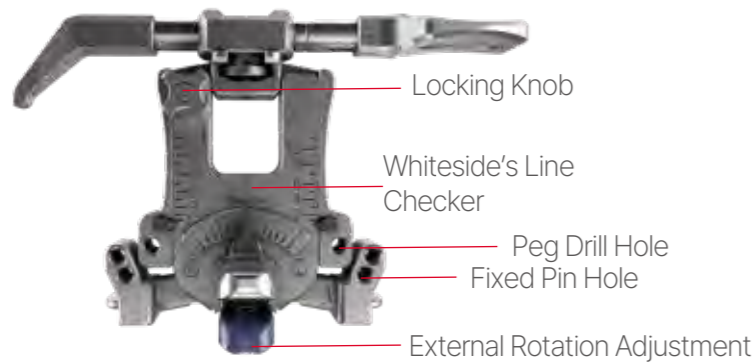

Figure 27

**Figure 26** The AP Sizer can be placed on the cut surface of the distal femur to measure the AP length.

**TIP**

The **Figure 27** is the anterior referencing method AP Sizer.

**Figure28** Position the stylus of the AP Sizer on the anterior femur. To check the location of the exterior flange of the Femoral Component, match the size of the AP Sizer main body to the size of the Stylus part.

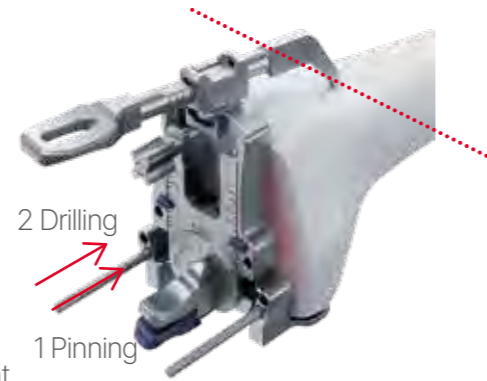

Figure 29

**Figure 29** When sizing and external rotation are completed, insert a pin into fixed pin hole to fix the AP size.

Use the Guide Drill to create alignment holes through the Peg Drill Hole.

The alignment holes serve as a reference for placing the 4-in-1 cutting block.

## 5 Femoral AP Resection Preparation



Figure 30



Figure 31



Figure 32

**Figure30** Align the 4-in-1 Cutting Block with the hole created using the AP Sizer and secure 4-in-1 Cutting Block to the resected distal femur.

**Figure 31** The saw blade runout can be checked by combining the Angel Wing with the slot in the anterior part of the 4-in-1 Cutting Block.

**Tip**

The 4-in-1 guide then needs to be removed, rotated 180°, and placed on the distal femur in the anterior holes. This will result in a 2 mm anterior shift of the 4-in-1 femoral resections.

## 6. Flexion Gap Assessment



Figure 33

**Figure 33** The gap gauge can be used to confirm the flexion gap between the femur with posterior resection and the tibia with proximal resection.

## 7. Femoral AP Resection

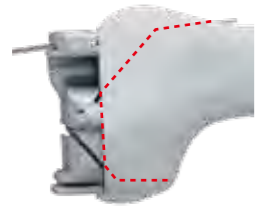

Figure 34



Figure 35

**Figure 34** Cut the Femur Anterior, Posterior, Posterior Chamfer, and Anterior Chamfer with the Oscillating saw blade through the Cut Slots of the 4-in-1 Cutting Block.

## 8. PS Notch Preparation

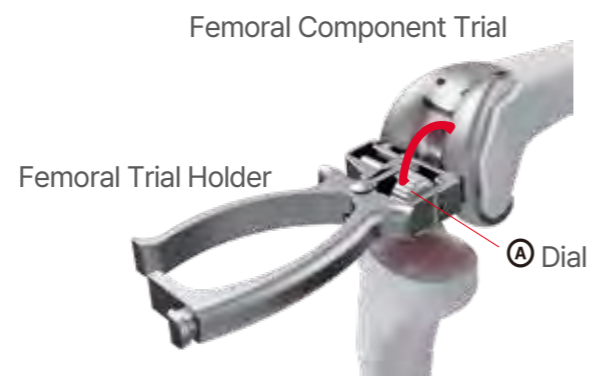

Figure 36

**Figure 36** Use the Femoral Trial Holder or Modular Femoral Impactor Head to position the Femoral Component Trial on the prepared Distal Femur.

### TIP

The size of the Femoral Component Trial can be changed the femoral trial holder can be adjusted to fit different size femoral trials by turning the Dial of the Femur Trial Holder.

## 8. PS Notch Preparation

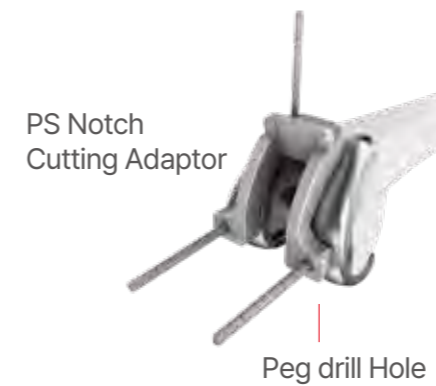

Figure 37



Figure 38



Figure 39

**Figure 37** Use Peg Drill Holes on Femoral trial to assemble a PS Notch Cutting adapter of the same Femoral Component Trial size. CPS types require the use of a CPS Notch Cutting Adapter.

Insert the headless pins into the anterior and distal guide holes of the PS Notch Cutting Adapter to secure the PS Notch Cutting Adapter and Femoral Component Trial.

**Figure 38** Chiseling with Femoral Protector and cutting into PS Notch from with oscillating or reciprocating saw.



Figure 39



Figure 40



Figure 41

**Figure 39** Assemble the PS Notch Trial with **Figure 40** the Femoral Component Trial to complete the PS Femoral Component Trial.

**Figure 41** Pull out and remove inward to the PS Notch Trial.

## 9. Tibial Keel Preparation



Figure 42

**Figure 42** Press the button on the Baseplate Trial Handle and attach it to the Tibial Baseplate Trial.

Release the button and make sure it is engaged.

Position the Tibial Baseplate Trial on the resected Proximal Tibial Bone.

Insert the headed pin into the Anterior and Posterior Holes on the Tibial Baseplate Trial and secure it.

Keel Punch Guide



Tibial Drill



Shared Handle



Figure 43

**Figure 43** Position the Keel Punch Guide with B button pressed on the Tibial Baseplate Trial. Make a keel shape using a Keel Punch through the Tibial Stem using a Tibial Drill.

## 10. Patella Preparation



Figure 44



Figure 45

**Figure 44** Measure the thickness of the Patella using Patella Calipers. Diameters of \*26, 28, 30, 32, 34, and \*36 mm are available. (\* Special order)

Patellar Size	Resection
*26, 28, 30,32 34, *36	8mm 9mm



Figure 46

**Figure 45** The resected amount can be predicted using the measurement section of the Patella Resection Guide.

The resection amount can be increased or decreased by turning the Knob of the Patella Resection Guide.

**Figure 46** Resect the Patella using the Saw Capture Slots in the Patella Resection Guide.

A 1.27mm saw blade is recommended for use in the capture slots of the Patella Resection Guide.

## 10. Patella Preparation



Figure 47



Figure 48



Figure 49

**Figure 47,48** Create fixation holes in the Patella using the Patella Peg Drill Guide and Patella Peg Drill.

Position the Patella Trial against the three Peg holes and push it in by hand.

**Figure 49** After Trial Reduction, apply cement to the resected Patella surface and Patella Component.

Position the Patella component against the three fixation holes and push the component by hand.

Subsequently, place the patella component on the Patella Clamp and tighten the handle until the Patella Clamp Head is tightly compressed.

Remove extra cement around the patella component with a Curette.

## 11. Trial Reduction



Figure 50



Figure 51



Figure 52

EM Guide

**Figure 50** Assemble the Tibial Insert Trial to the Tibial Baseplate Trial by applying pressure by hand.

The Tibial Insert Trial is provided in 9 mm to 24 mm thicknesses.

(\*special order 20mm, 22mm,24mm)

**Figure 51,52** Perform Trial Reduction (Alignment, Stability, and ROM) and select the final size.

## 12. Implanation



Figure 53



Figure 54



Figure 55



Figure 56

**Figure 53** The Modular Impaction Handle can be used with the Tibial Impactor Head, Femoral Impactor Head, and Insert Impactor Head.

Two Modular Impaction Handles are provided per instrument kit to improve efficiencies.

**Figure 54** Assemble the Tibial Impactor Head with the Modular Impaction Handle.

**Figure 55** Use the Femoral Impactor to fully seat the Femoral Component on the femur.

**Figure 56** Assemble the Tibial Insert Trial on the Tibial Baseplate and check the motion (Alignment, Stability, and ROM) again.



Figure 57



Figure 58

**Figure57** Assemble the Insert Impactor Head with the Modular Impaction Handle.

Use the Insert Impactor to impact the Tibial Insert interior groove area to ensure that the Tibial Insert is fully seated.

**Figure58** The implantation is complete

## Optional Tibia Stem Preparation



Figure 59

Figure 60



Figure 61

**Figure 59** Following the proximal resection of the tibia, combine the Reamer Guide with the Tibial Baseplate trial.

**Figure 60** Attach the Reamer Stopper to the desired depth of the Stem Extension Reamer.

**Figure 61** Ream until the reamer touches the Reamer Guide.

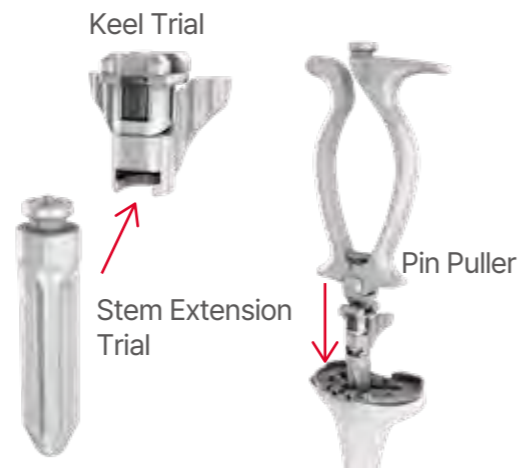

Figure 62

Figure 63



Figure 64

**Figure 62** Assemble the Keel Trial and Stem Extension Trial.

**Figure 63** Insert the Stem Extension Trial using the Pin Puller.

Remove the Stem Extension Trial with Pin Puller. If it is difficult to remove, remove it with a Slap Hammer.

**Figure 64** This is the appearance of the Tibial Trial during the Tibial Stem Extension.

**Figure 65** Since the Stem Plug is attached to the Stem Baseplate, it is necessary to disassemble the Stem Plug when using the Stem Extension.

**Figure 66** Position the Stem Extension Counter wrench at the bottom of the Tibial Baseplate and release the Stem Plug using the Stem Extension wrench.

When ready, use the thumb to push the wrench in the direction of the arrow.

Figure 65

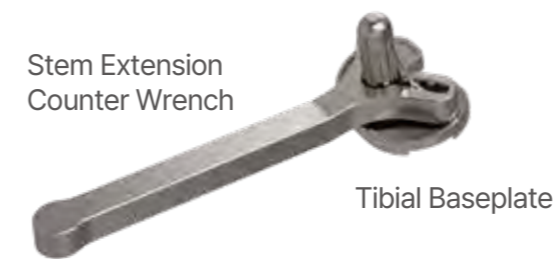

Figure 66



Place the Stem Extension Counter wrench on the Tibial Baseplate and lock it with the Torque Wrench.

The torque wrench can apply a force of 13.5–18 N.

Tighten the Stem Extension using a torque wrench for proper strength.

Insert the assembled Tibial Baseplate.

### TIP

**Figure 67** Trial and implant have the same extension length.

Figure 67

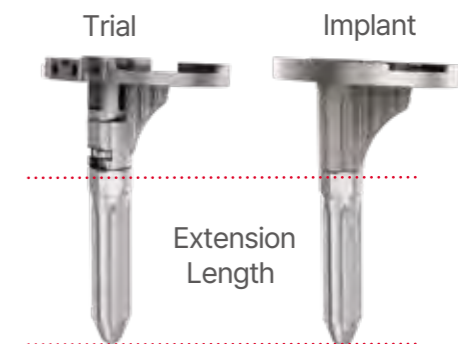

Figure 68



# Size Combination Chart

Tibial Components		Femoral Components												
		F1	F2	F3	F4	F5	F6	F7	F8	F9	F10	F11	F12	F13
		50/59	52/60	54/61	56/62	58/63.5	60/65	62/67	64/68.5	66/70	68/71.5	70/73	74/77	76/78
T2	36/57		●											
T3	38/60			●										
T4	40/63				●									
T5	42/66					●								
T6	44/69						●							
T7	45/72							●						
T8	47/75								●					
T9	50/79									●				
T10	53/83										●			
T11	57/86											●		

Tibial Inserts (UC Type)		Femoral Component (UC Type)												
		F1	F2	F3	F4	F5	F6	F7	F8	F9	F10	F11	F12	F13
		50/59	52/60	54/61	56/62	58/63.5	60/65	62/67	64/68.5	66/70	68/71.5	70/73	73/76	76/78
T2	36/57		●											
T3	38/60			●										
T4	40/63				●									
T5	42/66					●								
T6	44/69						●							
T7	45/72							●						
T8	47/75								●					
T9	50/79									●				
T10	53/83										●			
T11	57/86											●		

Tibial Inserts (CPS Type)		Femoral Component (CPS Type)												
		F1	F2	F3	F4	F5	F6	F7	F8	F9	F10	F11	F12	F13
		50/59	52/60	54/61	56/62	58/63.5	60/65	62/67	64/68.5	66/70	68/71.5	70/73	73/76	76/78
T2	36/57		●											
T3	38/60			●										
T4	40/63				●									
T5	42/66					●								
T6	44/69						●							
T7	45/72							●						
T8	47/75								●	T8P				
T9	50/79										●			
T10	53/83											●		
T11	57/86												●	

T8P: The combination of F9 and T8 size must use Tibial insert CPS #08 with a post width of 19mm(CPS #08P).  
 T9P: The combination of F8 and T9 size must use Tibial insert CPS #09 with a post width of 17mm(CPS #09P).

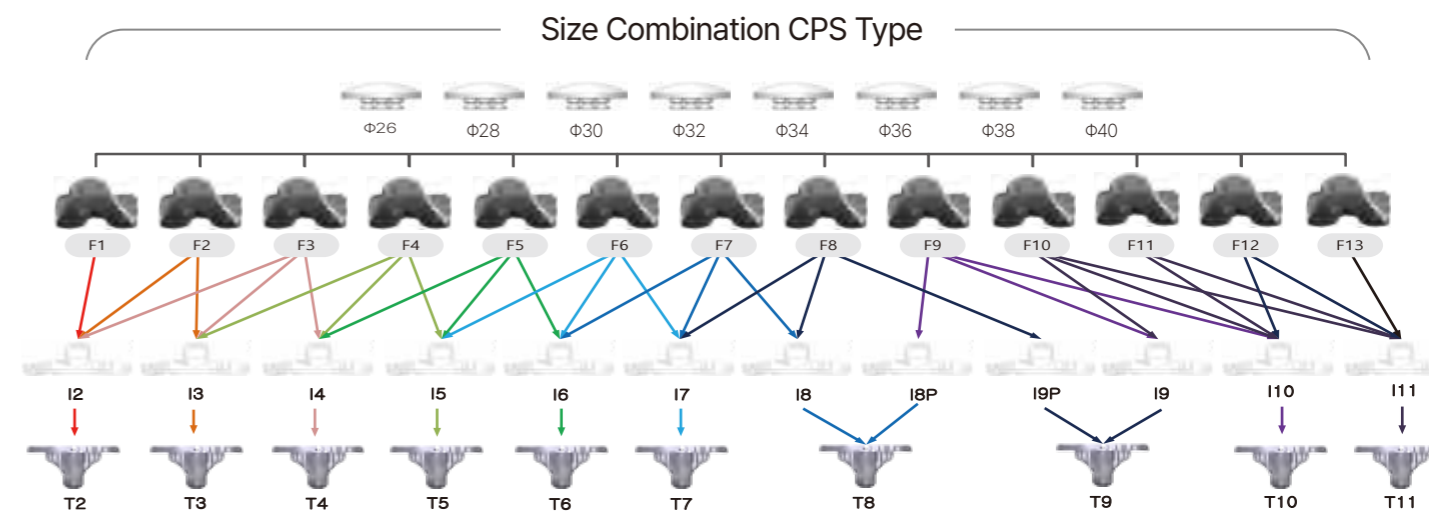
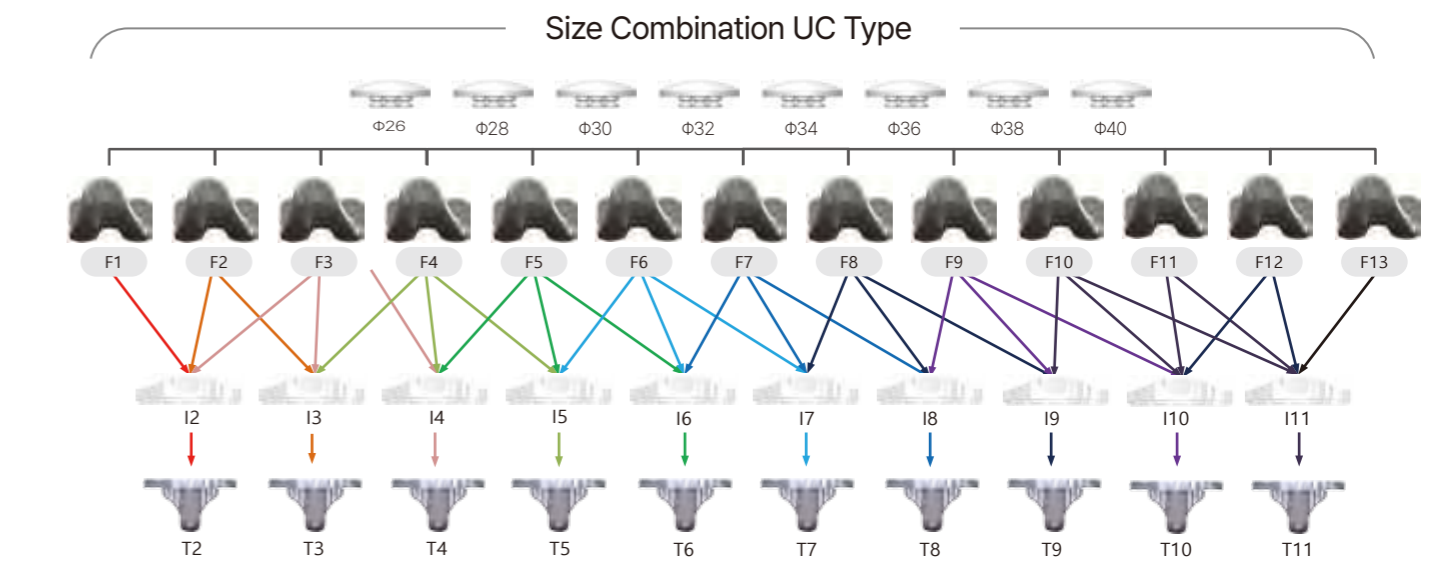
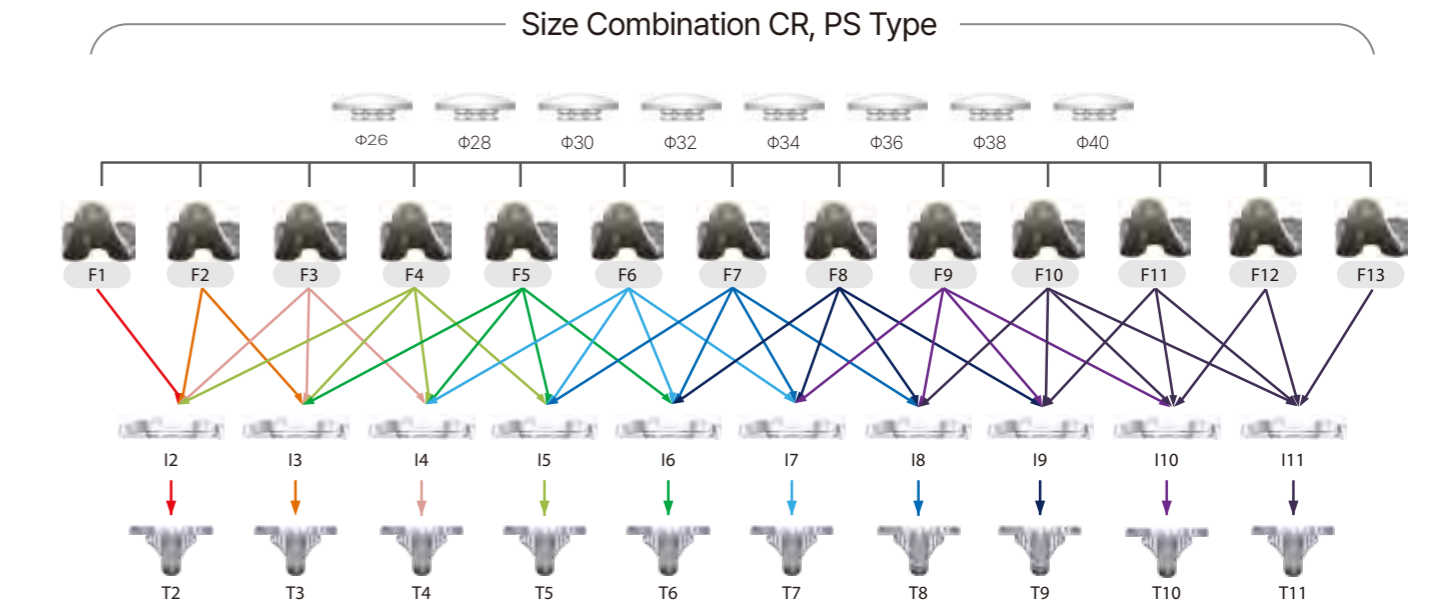

## Instrument Information

\* Special Order

Part No .	Description	Quantity	Tray
01.61.111	Twist drill	1	KC.CDF.E001
01.61.154	Femoral Condyle Drill	1	
KA.CFA.0001	IM Rod	1	
KA.FFA.0001	Femoral Alignment Guide	1	
KA.FFA.0003	Resection Tower	1	
KA.FFC.0020	Distal Cutting Guide	1	
KA.FFM.0001	AP Sizer EXT Rotation	1	
KA.CFD.0002	Position Drill	1	
KA.CFC.0002	4 in 1 Cutting Block #02*	1	
KA.CFC.0003	4 in 1 Cutting Block #03	1	
KA.CFC.0004	4 in 1 Cutting Block #04	1	
KA.CFC.0005	4 in 1 Cutting Block #05	1	
KA.CFC.0006	4 in 1 Cutting Block #06	1	
KA.CFC.0007	4 in 1 Cutting Block #07	1	
KA.CFC.0008	4 in 1 Cutting Block #08	1	
KA.CFC.0009	4 in 1 Cutting Block #09	1	
KA.CFC.0010	4 in 1 Cutting Block #10	1	
KA.CFC.0011	4 in 1 Cutting Block #11	1	
KA.CFC.0012	4 in 1 Cutting Block #12*	1	
KA.CFC.0013	4 in 1 Cutting Block #13*	1	
KA.CFC.BS02	PS Notch Cutting Adaptor #02 (Saw Capture)*	1	
KA.CFC.BS03	PS Notch Cutting Adaptor #03 (Saw Capture)	1	
KA.CFC.BS04	PS Notch Cutting Adaptor #04 (Saw Capture)	1	
KA.CFC.BS05	PS Notch Cutting Adaptor #05 (Saw Capture)	1	
KA.CFC.BS06	PS Notch Cutting Adaptor #06 (Saw Capture)	1	
KA.CFC.BS07	PS Notch Cutting Adaptor #07 (Saw Capture)	1	
KA.CFC.BS08	PS Notch Cutting Adaptor #08 (Saw Capture)	1	
KA.CFC.BS09	PS Notch Cutting Adaptor #09 (Saw Capture)	1	
KA.CFC.BS10	PS Notch Cutting Adaptor #10 (Saw Capture)	1	
KA.CFC.BS11	PS Notch Cutting Adaptor #11 (Saw Capture)	1	
KA.CFC.BS12	PS Notch Cutting Adaptor #12 (Saw Capture)*	1	
KA.CFC.BS13	PS Notch Cutting Adaptor #13 (Saw Capture)*	1	
01.61.154	Femoral condyle drill	1	
KA.CF0.N001	Femur Protector	1	
KA.CF0.N002	Femur Protector L	1	
KA.CFA.0002	Modular T-Handle	1	
KA.SFO.0008-PPX	Femoral Impactor	1	
KA.HGM.0001	Angel wing	1	
KA.HGA.0001	EM Alignment Rod	1	
KA.HGA.0002	EM Alignment Assembly Rod	1	
KA.HGA.0003	Alignment Rod Connector	1	
KA.HGF.0001	Pin Driver	1	
KA.HGF.0002	Headless Pin	6	
KA.HGF.0004	Headed Pin	6	
KA.HGF.0005	Threaded Pin	6	
KA.HGF.0006	Threaded Pin Driver	1	
KA.HG0.0001	Bone file	1	
KA.HGR.0012	Universal Extractor For Slap Hammer	1	
KA.HGR.0003	Slap Hammer	1	
KA.HGR.0001	Pin Puller	1	
			KC.CGS.E001

## Instrument Information

\* Special Order

Part No .	Description	Quantity	Tray
KA.CFI.0001-PPX	Femoral Impactor Head	1	KC.CGS.E001
KA.CTI.0001-PPX	Tibial Baseplate Impactor Head	1	
KA.CTI.0002-PPX	Tibial Insert Impactor Head	1	
KA.CGH.0001	Shared Handle	2	
KA.CFR.0001	Femur Trial Holder	1	
KA.HGM.0009	Gap Gage 09mm	1	
KA.HGM.0010	Attachment Plate 10mm (1T)	2	
KA.HGM.0011	Attachment Plate 11mm (2T)	2	
KA.HGM.0012	Attachment Plate 12mm (3T)	2	
KA.HGM.0013	Attachment Plate 13mm (4T)	2	
KA.HGM.0014	Attachment Plate 14mm (5T)	1	
KA.HGM.0016	Attachment Plate 16mm (7T)	1	
KA.HGM.0018	Attachment Plate 18mm (9T)	1	
KA.CTC.KRL3	Tibial Cutting Guide LT 3DEG	1	
KA.CTC.KRR3	Tibial Cutting Guide RT 3DEG	1	
KA.CTA.0001	Tibial Tower	1	
KA.CTA.0003	Ankle Clamp	1	
KA.CTM.0001	Tibial stylus 2~9mm	1	
KA.CTT.0002	Tibia Baseplate Trial Fixed 02*	1	
KA.CTT.0003	Tibia Baseplate Trial Fixed 03	1	
KA.CTT.0004	Tibia Baseplate Trial Fixed 04	1	
KA.CTT.0005	Tibia Baseplate Trial Fixed 05	1	
KA.CTT.0006	Tibia Baseplate Trial Fixed 06	1	
KA.CTT.0007	Tibia Baseplate Trial Fixed 07	1	
KA.CTT.0008	Tibia Baseplate Trial Fixed 08	1	
KA.CTT.0009	Tibia Baseplate Trial Fixed 09	1	
KA.CTT.0010	Tibia Baseplate Trial Fixed 10	1	
KA.CTT.0011	Tibia Baseplate Trial Fixed 11	1	
KA.CTH.0001	Baseplate Trial Handle	2	
KA.CTG.0001	Keel Punch Guide	1	
KA.CTD.0001	Tibial Stem Drill #01~08	1	
KA.CTD.0002	Tibial Stem Drill #09~11	1	
KA.CTC.000S	Keel Punch Head #S	1	
KA.CTC.000M	Keel Punch Head #M	1	
KA.CTC.000L	Keel Punch Head #L	1	
KA.HGM.0009-PPX	Gap Gage 09mm	1	
KA.HGM.0010	Attachment Plate 10mm (1T)	2	
KA.HGM.0011	Attachment Plate 11mm (2T)	2	
KA.HGM.0012	Attachment Plate 12mm (3T)	2	
KA.HGM.0013	Attachment Plate 13mm (4T)	2	
KA.HGM.0014	Attachment Plate 14mm (5T)	1	
KA.HGM.0016	Attachment Plate 16mm (7T)	1	
KA.HGM.0018	Attachment Plate 18mm (9T)	1	
KA.XTT.S001	Keel Trial #02~08	1	
KA.XTT.L001	Keel Trial #09~11	1	
			KC.CGT.E001

\* Special Order

Part No .	Description	Quantity	Tray
KA.CFT.L002	Femoral Component Trial Left #02*	1	KC.CTF.E001
KA.CFT.L003	Femoral Component Trial Left #03	1	
KA.CFT.L004	Femoral Component Trial Left #04	1	
KA.CFT.L005	Femoral Component Trial Left #05	1	
KA.CFT.L006	Femoral Component Trial Left #06	1	
KA.CFT.L007	Femoral Component Trial Left #07	1	
KA.CFT.L008	Femoral Component Trial Left #08	1	
KA.CFT.L009	Femoral Component Trial Left #09	1	
KA.CFT.L010	Femoral Component Trial Left #10	1	
KA.CFT.L011	Femoral Component Trial Left #11	1	
KA.CFT.L012	Femoral Component Trial Left #12*	1	
KA.CFT.L013	Femoral Component Trial Left #13*	1	
KA.CFT.R002	Femoral Component Trial Right #02*	1	
KA.CFT.R003	Femoral Component Trial Right #03	1	
KA.CFT.R004	Femoral Component Trial Right #04	1	
KA.CFT.R005	Femoral Component Trial Right #05	1	
KA.CFT.R006	Femoral Component Trial Right #06	1	
KA.CFT.R007	Femoral Component Trial Right #07	1	
KA.CFT.R008	Femoral Component Trial Right #08	1	
KA.CFT.R009	Femoral Component Trial Right #09	1	
KA.CFT.R010	Femoral Component Trial Right #10	1	
KA.CFT.R011	Femoral Component Trial Right #11	1	
KA.CFT.R012	Femoral Component Trial Right #12*	1	
KA.CFT.R013	Femoral Component Trial Right #13*	1	
KA.CFT.L003-SUS	Femoral Component Trial Left #03	1	
KA.CFT.L004-SUS	Femoral Component Trial Left #04	1	
KA.CFT.L005-SUS	Femoral Component Trial Left #05	1	
KA.CFT.L006-SUS	Femoral Component Trial Left #06	1	
KA.CFT.L007-SUS	Femoral Component Trial Left #07	1	
KA.CFT.L008-SUS	Femoral Component Trial Left #08	1	
KA.CFT.L009-SUS	Femoral Component Trial Left #09	1	
KA.CFT.L010-SUS	Femoral Component Trial Left #10	1	
KA.CFT.L011-SUS	Femoral Component Trial Left #11	1	
KA.CFT.L012-SUS	Femoral Component Trial Left #12*	1	
KA.CFT.L013-SUS	Femoral Component Trial Left #13*	1	
KA.CFT.R002-SUS	Femoral Component Trial Right #02*	1	
KA.CFT.R003-SUS	Femoral Component Trial Right #03	1	
KA.CFT.R004-SUS	Femoral Component Trial Right #04	1	
KA.CFT.R005-SUS	Femoral Component Trial Right #05	1	
KA.CFT.R006-SUS	Femoral Component Trial Right #06	1	
KA.CFT.R007-SUS	Femoral Component Trial Right #07	1	
KA.CFT.R008-SUS	Femoral Component Trial Right #08	1	
KA.CFT.R009-SUS	Femoral Component Trial Right #09	1	
KA.CFT.R010-SUS	Femoral Component Trial Right #10	1	
KA.CFT.R011-SUS	Femoral Component Trial Right #11	1	
KA.CFT.R012-SUS	Femoral Component Trial Right #12*	1	
KA.CFT.R013-SUS	Femoral Component Trial Right #13*	1	
KA.CFT.N002	PS Notch Trial #02*	1	
KA.CFT.N003	PS Notch Trial #03	1	
KA.CFT.N004	PS Notch Trial #04	1	
KA.CFT.N005	PS Notch Trial #05	1	

# Instrument Information

\* Special Order

Part No.	Description	Quantity	Tray
KA.CFT.N006	PS Notch Trial #06	1	KC.CTF.E001
KA.CFT.N007	PS Notch Trial #07	1	
KA.CFT.N008	PS Notch Trial #08	1	
KA.CFT.N009	PS Notch Trial #09	1	
KA.CFT.N010	PS Notch Trial #10	1	
KA.CFT.N011	PS Notch Trial #11	1	
KA.CFT.N012	PS Notch Trial #12*	1	
KA.CFT.N013	PS Notch Trial #13*	1	
KA.ICR.0209-PPX	Tibial Insert Trial CR #02 T09	1	
KA.ICR.0210-PPX	Tibial Insert Trial CR #02 T10	1	
KA.ICR.0211-PPX	Tibial Insert Trial CR #02 T11	1	
KA.ICR.0212-PPX	Tibial Insert Trial CR #02 T12	1	
KA.ICR.0213-PPX	Tibial Insert Trial CR #02 T13	1	
KA.ICR.0214-PPX	Tibial Insert Trial CR #02 T14	1	
KA.ICR.0216-PPX	Tibial Insert Trial CR #02 T16	1	
KA.ICR.0218-PPX	Tibial Insert Trial CR #02 T18	1	
KA.ICR.0220-PPX	Tibial Insert Trial CR #02 T20*	1	
KA.ICR.0309-PPX	Tibial Insert Trial CR #03 T09	1	
KA.ICR.0310-PPX	Tibial Insert Trial CR #03 T10	1	
KA.ICR.0311-PPX	Tibial Insert Trial CR #03 T11	1	
KA.ICR.0312-PPX	Tibial Insert Trial CR #03 T12	1	
KA.ICR.0313-PPX	Tibial Insert Trial CR #03 T13	1	
KA.ICR.0314-PPX	Tibial Insert Trial CR #03 T14	1	
KA.ICR.0316-PPX	Tibial Insert Trial CR #03 T16	1	
KA.ICR.0318-PPX	Tibial Insert Trial CR #03 T18	1	
KA.ICR.0320-PPX	Tibial Insert Trial CR #03 T20*	1	
KA.ICR.0409-PPX	Tibial Insert Trial CR #04 T09	1	
KA.ICR.0410-PPX	Tibial Insert Trial CR #04 T10	1	
KA.ICR.0411-PPX	Tibial Insert Trial CR #04 T11	1	
KA.ICR.0412-PPX	Tibial Insert Trial CR #04 T12	1	
KA.ICR.0413-PPX	Tibial Insert Trial CR #04 T13	1	
KA.ICR.0414-PPX	Tibial Insert Trial CR #04 T14	1	
KA.ICR.0416-PPX	Tibial Insert Trial CR #04 T16	1	
KA.ICR.0418-PPX	Tibial Insert Trial CR #04 T18	1	
KA.ICR.0420-PPX	Tibial Insert Trial CR #04 T20*	1	
KA.ICR.0509-PPX	Tibial Insert Trial CR #05 T09	1	
KA.ICR.0510-PPX	Tibial Insert Trial CR #05 T10	1	
KA.ICR.0511-PPX	Tibial Insert Trial CR #05 T11	1	
KA.ICR.0512-PPX	Tibial Insert Trial CR #05 T12	1	
KA.ICR.0513-PPX	Tibial Insert Trial CR #05 T13	1	
KA.ICR.0514-PPX	Tibial Insert Trial CR #05 T14	1	
KA.ICR.0516-PPX	Tibial Insert Trial CR #05 T16	1	
KA.ICR.0518-PPX	Tibial Insert Trial CR #05 T18	1	
KA.ICR.0520-PPX	Tibial Insert Trial CR #05 T20*	1	
KA.ICR.0609-PPX	Tibial Insert Trial CR #06 T09	1	
KA.ICR.0610-PPX	Tibial Insert Trial CR #06 T10	1	
KA.ICR.0611-PPX	Tibial Insert Trial CR #06 T11	1	
KA.ICR.0612-PPX	Tibial Insert Trial CR #06 T12	1	
KA.ICR.0613-PPX	Tibial Insert Trial CR #06 T13	1	
KA.ICR.0614-PPX	Tibial Insert Trial CR #06 T14	1	
KA.ICR.0616-PPX	Tibial Insert Trial CR #06 T16	1	

\* Special Order

Part No.	Description	Quantity	Tray
KA.ICR.0618-PPX	Tibial Insert Trial CR #06 T18	1	KC.CTT.E0PS
KA.ICR.0620-PPX	Tibial Insert Trial CR #06 T20*	1	
KA.ICR.0709-PPX	Tibial Insert Trial CR #07 T09	1	
KA.ICR.0710-PPX	Tibial Insert Trial CR #07 T10	1	
KA.ICR.0711-PPX	Tibial Insert Trial CR #07 T11	1	
KA.ICR.0712-PPX	Tibial Insert Trial CR #07 T12	1	
KA.ICR.0713-PPX	Tibial Insert Trial CR #07 T13	1	
KA.ICR.0714-PPX	Tibial Insert Trial CR #07 T14	1	
KA.ICR.0716-PPX	Tibial Insert Trial CR #07 T16	1	
KA.ICR.0718-PPX	Tibial Insert Trial CR #07 T18	1	
KA.ICR.0720-PPX	Tibial Insert Trial CR #07 T20*	1	
KA.ICR.0809-PPX	Tibial Insert Trial CR #08 T09	1	
KA.ICR.0810-PPX	Tibial Insert Trial CR #08 T10	1	
KA.ICR.0811-PPX	Tibial Insert Trial CR #08 T11	1	
KA.ICR.0812-PPX	Tibial Insert Trial CR #08 T12	1	
KA.ICR.0813-PPX	Tibial Insert Trial CR #08 T13	1	
KA.ICR.0814-PPX	Tibial Insert Trial CR #08 T14	1	
KA.ICR.0816-PPX	Tibial Insert Trial CR #08 T16	1	
KA.ICR.0818-PPX	Tibial Insert Trial CR #08 T18	1	
KA.ICR.0820-PPX	Tibial Insert Trial CR #08 T20*	1	
KA.ICR.0909-PPX	Tibial Insert Trial CR #09 T09	1	
KA.ICR.0910-PPX	Tibial Insert Trial CR #09 T10	1	
KA.ICR.0911-PPX	Tibial Insert Trial CR #09 T11	1	
KA.ICR.0912-PPX	Tibial Insert Trial CR #09 T12	1	
KA.ICR.0913-PPX	Tibial Insert Trial CR #09 T13	1	
KA.ICR.0914-PPX	Tibial Insert Trial CR #09 T14	1	
KA.ICR.0916-PPX	Tibial Insert Trial CR #09 T16	1	
KA.ICR.0918-PPX	Tibial Insert Trial CR #09 T18	1	
KA.ICR.0920-PPX	Tibial Insert Trial CR #09 T20*	1	
KA.ICR.1009-PPX	Tibial Insert Trial CR #10 T09	1	
KA.ICR.1010-PPX	Tibial Insert Trial CR #10 T10	1	
KA.ICR.1011-PPX	Tibial Insert Trial CR #10 T11	1	
KA.ICR.1012-PPX	Tibial Insert Trial CR #10 T12	1	
KA.ICR.1013-PPX	Tibial Insert Trial CR #10 T13	1	
KA.ICR.1014-PPX	Tibial Insert Trial CR #10 T14	1	
KA.ICR.1016-PPX	Tibial Insert Trial CR #10 T16	1	
KA.ICR.1018-PPX	Tibial Insert Trial CR #10 T18	1	
KA.ICR.1020-PPX	Tibial Insert Trial CR #10 T20*	1	
KA.ICR.1109-PPX	Tibial Insert Trial CR #11 T09	1	
KA.ICR.1110-PPX	Tibial Insert Trial CR #11 T10	1	
KA.ICR.1111-PPX	Tibial Insert Trial CR #11 T11	1	
KA.ICR.1112-PPX	Tibial Insert Trial CR #11 T12	1	
KA.ICR.1113-PPX	Tibial Insert Trial CR #11 T13	1	
KA.ICR.1114-PPX	Tibial Insert Trial CR #11 T14	1	
KA.ICR.1116-PPX	Tibial Insert Trial CR #11 T16	1	
KA.ICR.1118-PPX	Tibial Insert Trial CR #11 T18	1	
KA.ICR.1120-PPX	Tibial Insert Trial CR #11 T20*	1	

## Instrument Information

\* Special Order

Part No .	Description	Quantity	Tray
KA.IPS.0411-PPX	Tibial Insert Trial PS #04 T11	1	KC.CTT.EOPS
KA.IPS.0412-PPX	Tibial Insert Trial PS #04 T12	1	
KA.IPS.0413-PPX	Tibial Insert Trial PS #04 T13	1	
KA.IPS.0414-PPX	Tibial Insert Trial PS #04 T14	1	
KA.IPS.0416-PPX	Tibial Insert Trial PS #04 T16	1	
KA.IPS.0418-PPX	Tibial Insert Trial PS #04 T18	1	
KA.IPS.0420-PPX	Tibial Insert Trial PS #04 T20*	1	
KA.IPS.0509-PPX	Tibial Insert Trial PS #05 T09	1	
KA.IPS.0510-PPX	Tibial Insert Trial PS #05 T10	1	
KA.IPS.0511-PPX	Tibial Insert Trial PS #05 T11	1	
KA.IPS.0512-PPX	Tibial Insert Trial PS #05 T12	1	
KA.IPS.0513-PPX	Tibial Insert Trial PS #05 T13	1	
KA.IPS.0514-PPX	Tibial Insert Trial PS #05 T14	1	
KA.IPS.0516-PPX	Tibial Insert Trial PS #05 T16	1	
KA.IPS.0518-PPX	Tibial Insert Trial PS #05 T18	1	
KA.IPS.0520-PPX	Tibial Insert Trial PS #05 T20*	1	
KA.IPS.0609-PPX	Tibial Insert Trial PS #06 T09	1	
KA.IPS.0610-PPX	Tibial Insert Trial PS #06 T10	1	
KA.IPS.0611-PPX	Tibial Insert Trial PS #06 T11	1	
KA.IPS.0612-PPX	Tibial Insert Trial PS #06 T12	1	
KA.IPS.0613-PPX	Tibial Insert Trial PS #06 T13	1	
KA.IPS.0614-PPX	Tibial Insert Trial PS #06 T14	1	
KA.IPS.0616-PPX	Tibial Insert Trial PS #06 T16	1	
KA.IPS.0618-PPX	Tibial Insert Trial PS #06 T18	1	
KA.IPS.0620-PPX	Tibial Insert Trial PS #06 T20*	1	
KA.IPS.0709-PPX	Tibial Insert Trial PS #07 T09	1	
KA.IPS.0710-PPX	Tibial Insert Trial PS #07 T10	1	
KA.IPS.0711-PPX	Tibial Insert Trial PS #07 T11	1	
KA.IPS.0712-PPX	Tibial Insert Trial PS #07 T12	1	
KA.IPS.0713-PPX	Tibial Insert Trial PS #07 T13	1	
KA.IPS.0714-PPX	Tibial Insert Trial PS #07 T14	1	
KA.IPS.0716-PPX	Tibial Insert Trial PS #07 T16	1	
KA.IPS.0718-PPX	Tibial Insert Trial PS #07 T18	1	
KA.IPS.0720-PPX	Tibial Insert Trial PS #07 T20*	1	
KA.IPS.0809-PPX	Tibial Insert Trial PS #08 T09	1	
KA.IPS.0810-PPX	Tibial Insert Trial PS #08 T10	1	
KA.IPS.0811-PPX	Tibial Insert Trial PS #08 T11	1	
KA.IPS.0812-PPX	Tibial Insert Trial PS #08 T12	1	
KA.IPS.0813-PPX	Tibial Insert Trial PS #08 T13	1	
KA.IPS.0814-PPX	Tibial Insert Trial PS #08 T14	1	
KA.IPS.0816-PPX	Tibial Insert Trial PS #08 T16	1	
KA.IPS.0818-PPX	Tibial Insert Trial PS #08 T18	1	
KA.IPS.0820-PPX	Tibial Insert Trial PS #08 T20*	1	
KA.IPS.0909-PPX	Tibial Insert Trial PS #09 T09	1	
KA.IPS.0910-PPX	Tibial Insert Trial PS #09 T10	1	
KA.IPS.0911-PPX	Tibial Insert Trial PS #09 T11	1	
KA.IPS.0912-PPX	Tibial Insert Trial PS #09 T12	1	
KA.IPS.0913-PPX	Tibial Insert Trial PS #09 T13	1	
KA.IPS.0914-PPX	Tibial Insert Trial PS #09 T14	1	
KA.IPS.0916-PPX	Tibial Insert Trial PS #09 T16	1	
KA.IPS.0918-PPX	Tibial Insert Trial PS #09 T18	1	
KA.IPS.0920-PPX	Tibial Insert Trial PS #09 T20*	1	

\* Special Order

Part No .	Description	Quantity	Tray
KA.IPS.1009-PPX	Tibial Insert Trial PS #10 T09	1	KC.CTT.EOPS
KA.IPS.1010-PPX	Tibial Insert Trial PS #10 T10	1	
KA.IPS.1011-PPX	Tibial Insert Trial PS #10 T11	1	
KA.IPS.1012-PPX	Tibial Insert Trial PS #10 T12	1	
KA.IPS.1013-PPX	Tibial Insert Trial PS #10 T13	1	
KA.IPS.1014-PPX	Tibial Insert Trial PS #10 T14	1	
KA.IPS.1016-PPX	Tibial Insert Trial PS #10 T16	1	
KA.IPS.1018-PPX	Tibial Insert Trial PS #10 T18	1	
KA.IPS.1020-PPX	Tibial Insert Trial PS #10 T20*	1	
KA.IPS.1109-PPX	Tibial Insert Trial PS #11 T09	1	
KA.IPS.1110-PPX	Tibial Insert Trial PS #11 T10	1	
KA.IPS.1111-PPX	Tibial Insert Trial PS #11 T11	1	
KA.IPS.1112-PPX	Tibial Insert Trial PS #11 T12	1	
KA.IPS.1113-PPX	Tibial Insert Trial PS #11 T13	1	
KA.IPS.1114-PPX	Tibial Insert Trial PS #11 T14	1	
KA.IPS.1116-PPX	Tibial Insert Trial PS #11 T16	1	
KA.IPS.1118-PPX	Tibial Insert Trial PS #11 T18	1	
KA.IPS.1120-PPX	Tibial Insert Trial PS #11 T20*	1	
01.61.200	Patella resection guide	1	Tray x
01.61.201-PPX	Patella Clamp	1	
KA.SPC.0002	Patella peg drill	1	
KA.SPC.0010	Patella peg drill guide (30, 32)	1	
KA.SPC.0011	Patella peg drill guide (34, 36)	1	
KA.SPC.0013	Patella peg drill guide (26, 28)	1	
01.61.206	Patella calipers	1	
01.62.941	Patella trial - B type - Ø28X8mm	1	
01.62.96A	Patella trial - B type - 30X8mm	1	
01.62.98A	Patella trial - B type - 32X8mm	1	
01.62.9AB	Patella trial - B type - 34X9mm	1	
KA.XTD.0001	Stem Extension Reamer*	1	KC.COT.E001
KA.XTD.0002	Reamer Stopper*	1	
KA.XTG.0001	Reamer Guide #02~08*	1	
KA.XTG.0002	Reamer Guide #09~11*	1	
KA.XTT.1430	Stem Extension Trial D14 L30*	1	
KA.XTT.1460	Stem Extension Trial D14 L60*	1	
KA.XTT.1490	Stem Extension Trial D14 L90*	1	
KA.XTT.S001	Keel Trial #02-08*	1	
KA.XTT.L001	Keel Trial #09-11*	1	

## Instrument Information (CPS)

\* Special Order

Part No .	Description	Quantity	Tray
KA.CFC.BC01	CPS Notch Cutting Adaptor #01 (Saw Capture)	1	
KA.CFC.BC02	CPS Notch Cutting Adaptor #02 (Saw Capture)	1	
KA.CFC.BC03	CPS Notch Cutting Adaptor #03 (Saw Capture)	1	
KA.CFC.BC04	CPS Notch Cutting Adaptor #04 (Saw Capture)	1	
KA.CFC.BC05	CPS Notch Cutting Adaptor #05 (Saw Capture)	1	
KA.CFC.BC06	CPS Notch Cutting Adaptor #06 (Saw Capture)	1	
KA.CFC.BC07	CPS Notch Cutting Adaptor #07 (Saw Capture)	1	
KA.CFC.BC08	CPS Notch Cutting Adaptor #08 (Saw Capture)	1	
KA.CFC.BC09	CPS Notch Cutting Adaptor #09 (Saw Capture)	1	
KA.CFC.BC10	CPS Notch Cutting Adaptor #10 (Saw Capture)	1	
KA.CFC.BC11	CPS Notch Cutting Adaptor #11 (Saw Capture)	1	
KA.CFC.BC12	CPS Notch Cutting Adaptor #12 (Saw Capture)	1	
KA.ICP.0209	Tibial Insert Trial CPS #02 T09	1	
KA.ICP.0210	Tibial Insert Trial CPS #02 T10	1	
KA.ICP.0211	Tibial Insert Trial CPS #02 T11	1	
KA.ICP.0212	Tibial Insert Trial CPS #02 T12	1	
KA.ICP.0213	Tibial Insert Trial CPS #02 T13	1	
KA.ICP.0214	Tibial Insert Trial CPS #02 T14	1	
KA.ICP.0309	Tibial Insert Trial CPS #03 T09	1	
KA.ICP.0310	Tibial Insert Trial CPS #03 T10	1	
KA.ICP.0311	Tibial Insert Trial CPS #03 T11	1	
KA.ICP.0312	Tibial Insert Trial CPS #03 T12	1	
KA.ICP.0313	Tibial Insert Trial CPS #03 T13	1	
KA.ICP.0314	Tibial Insert Trial CPS #03 T14	1	
KA.ICP.0409	Tibial Insert Trial CPS #04 T09	1	
KA.ICP.0410	Tibial Insert Trial CPS #04 T10	1	KC.CTT.ECP1
KA.ICP.0411	Tibial Insert Trial CPS #04 T11	1	
KA.ICP.0412	Tibial Insert Trial CPS #04 T12	1	
KA.ICP.0413	Tibial Insert Trial CPS #04 T13	1	
KA.ICP.0414	Tibial Insert Trial CPS #04 T14	1	
KA.ICP.0509	Tibial Insert Trial CPS #05 T09	1	
KA.ICP.0510	Tibial Insert Trial CPS #05 T10	1	
KA.ICP.0511	Tibial Insert Trial CPS #05 T11	1	
KA.ICP.0512	Tibial Insert Trial CPS #05 T12	1	
KA.ICP.0513	Tibial Insert Trial CPS #05 T13	1	
KA.ICP.0514	Tibial Insert Trial CPS #05 T14	1	
KA.ICP.0609	Tibial Insert Trial CPS #06 T09	1	
KA.ICP.0610	Tibial Insert Trial CPS #06 T10	1	
KA.ICP.0611	Tibial Insert Trial CPS #06 T11	1	
KA.ICP.0612	Tibial Insert Trial CPS #06 T12	1	
KA.ICP.0613	Tibial Insert Trial CPS #06 T13	1	
KA.ICP.0614	Tibial Insert Trial CPS #06 T14	1	
KA.ICP.0709	Tibial Insert Trial CPS #07 T09	1	
KA.ICP.0710	Tibial Insert Trial CPS #07 T10	1	
KA.ICP.0711	Tibial Insert Trial CPS #07 T11	1	
KA.ICP.0712	Tibial Insert Trial CPS #07 T12	1	
KA.ICP.0713	Tibial Insert Trial CPS #07 T13	1	
KA.ICP.0714	Tibial Insert Trial CPS #07 T14	1	
KA.ICP.0809	Tibial Insert Trial CPS #08 T09	1	
KA.ICP.0810	Tibial Insert Trial CPS #08 T10	1	
KA.ICP.0811	Tibial Insert Trial CPS #08 T11	1	

\* Special Order

Part No .	Description	Quantity	Tray
KA.ICP.0812	Tibial Insert Trial CPS #08 T12	1	
KA.ICP.0813	Tibial Insert Trial CPS #08 T13	1	
KA.ICP.0814	Tibial Insert Trial CPS #08 T14	1	
KA.ICP.P809	Tibial Insert Trial CPS_post 19mm #08 T09	1	
KA.ICP.P810	Tibial Insert Trial CPS_post 19mm #08 T10	1	
KA.ICP.P811	Tibial Insert Trial CPS_post 19mm #08 T11	1	
KA.ICP.P812	Tibial Insert Trial CPS_post 19mm #08 T12	1	
KA.ICP.P813	Tibial Insert Trial CPS_post 19mm #08 T13	1	
KA.ICP.P814	Tibial Insert Trial CPS_post 19mm #08 T14	1	
KA.ICP.0909	Tibial Insert Trial CPS #09 T09	1	
KA.ICP.0910	Tibial Insert Trial CPS #09 T10	1	
KA.ICP.0911	Tibial Insert Trial CPS #09 T11	1	
KA.ICP.0912	Tibial Insert Trial CPS #09 T12	1	
KA.ICP.0913	Tibial Insert Trial CPS #09 T13	1	
KA.ICP.0914	Tibial Insert Trial CPS #09 T14	1	
KA.ICP.P909	Tibial Insert Trial CPS_post 17mm #09 T09	1	
KA.ICP.P910	Tibial Insert Trial CPS_post 17mm #09 T10	1	KC.CTT.ECP1
KA.ICP.P911	Tibial Insert Trial CPS_post 17mm #09 T11	1	
KA.ICP.P912	Tibial Insert Trial CPS_post 17mm #09 T12	1	
KA.ICP.P913	Tibial Insert Trial CPS_post 17mm #09 T13	1	
KA.ICP.P914	Tibial Insert Trial CPS_post 17mm #09 T14	1	
KA.ICP.1009	Tibial Insert Trial CPS #10 T09	1	
KA.ICP.1010	Tibial Insert Trial CPS #10 T10	1	
KA.ICP.1011	Tibial Insert Trial CPS #10 T11	1	
KA.ICP.1012	Tibial Insert Trial CPS #10 T12	1	
KA.ICP.1013	Tibial Insert Trial CPS #10 T13	1	
KA.ICP.1014	Tibial Insert Trial CPS #10 T14	1	
KA.ICP.1109	Tibial Insert Trial CPS #11 T09	1	
KA.ICP.1110	Tibial Insert Trial CPS #11 T10	1	
KA.ICP.1111	Tibial Insert Trial CPS #11 T11	1	
KA.ICP.1112	Tibial Insert Trial CPS #11 T12	1	
KA.ICP.1113	Tibial Insert Trial CPS #11 T13	1	
KA.ICP.1114	Tibial Insert Trial CPS #11 T14	1	
KA.ICP.0216	Tibial Insert Trial CPS #02 T16	1	
KA.ICP.0218	Tibial Insert Trial CPS #02 T18	1	
KA.ICP.0220	Tibial Insert Trial CPS #02 T20*	1	
KA.ICP.0316	Tibial Insert Trial CPS #03 T16	1	
KA.ICP.0318	Tibial Insert Trial CPS #03 T18	1	
KA.ICP.0320	Tibial Insert Trial CPS #03 T20*	1	
KA.ICP.0416	Tibial Insert Trial CPS #04 T16	1	
KA.ICP.0418	Tibial Insert Trial CPS #04 T18	1	
KA.ICP.0420	Tibial Insert Trial CPS #04 T20*	1	
KA.ICP.0516	Tibial Insert Trial CPS #05 T16	1	
KA.ICP.0518	Tibial Insert Trial CPS #05 T18	1	
KA.ICP.0520	Tibial Insert Trial CPS #05 T20*	1	
KA.ICP.0616	Tibial Insert Trial CPS #06 T16	1	
KA.ICP.0618	Tibial Insert Trial CPS #06 T18	1	
KA.ICP.0620	Tibial Insert Trial CPS #06 T20*	1	
KA.ICP.0716	Tibial Insert Trial CPS #07 T16	1	
KA.ICP.0718	Tibial Insert Trial CPS #07 T18	1	
KA.ICP.0720	Tibial Insert Trial CPS #07 T20*	1	
KA.ICP.0816	Tibial Insert Trial CPS #08 T16	1	
KA.ICP.0818	Tibial Insert Trial CPS #08 T18	1	
KA.ICP.0820	Tibial Insert Trial CPS #08 T20*	1	
KA.ICP.P816	Tibial Insert Trial CPS_post 19mm #08 T16	1	
KA.ICP.P818	Tibial Insert Trial CPS_post 19mm #08 T18	1	
KA.ICP.P820	Tibial Insert Trial CPS_post 19mm #08 T20*	1	
KA.ICP.0916	Tibial Insert Trial CPS #09 T16	1	
KA.ICP.0918	Tibial Insert Trial CPS #09 T18	1	
KA.ICP.0920	Tibial Insert Trial CPS #09 T20*	1	
KA.ICP.P916	Tibial Insert Trial CPS_post 17mm #09 T16	1	
KA.ICP.P918	Tibial Insert Trial CPS_post 17mm #09 T18	1	
KA.ICP.P920	Tibial Insert Trial CPS_post 17mm #09 T20*	1	
KA.ICP.1016	Tibial Insert Trial CPS #10 T16	1	
KA.ICP.1018	Tibial Insert Trial CPS #10 T18	1	
KA.ICP.1020	Tibial Insert Trial CPS #10 T20*	1	
KA.ICP.1116	Tibial Insert Trial CPS #11 T16	1	
KA.ICP.1118	Tibial Insert Trial CPS #11 T18	1	
KA.ICP.1120	Tibial Insert Trial CPS #11 T20*	1	

KC.CTT.ECP2

## Instrument Information (UC)

\*Special Order

Part No .	Description	Quantity	Tray
KA.IUC.0209	Tibial Insert Trial UC #02 T09	1	KC.CTT.E0UC
KA.IUC.0210	Tibial Insert Trial UC #02 T10	1	
KA.IUC.0211	Tibial Insert Trial UC #02 T11	1	
KA.IUC.0212	Tibial Insert Trial UC #02 T12	1	
KA.IUC.0213	Tibial Insert Trial UC #02 T13	1	
KA.IUC.0214	Tibial Insert Trial UC #02 T14	1	
KA.IUC.0216	Tibial Insert Trial UC #02 T16	1	
KA.IUC.0218	Tibial Insert Trial UC #02 T18	1	
KA.IUC.0220	Tibial Insert Trial UC #02 T20*	1	
KA.IUC.0309	Tibial Insert Trial UC #03 T09	1	
KA.IUC.0310	Tibial Insert Trial UC #03 T10	1	
KA.IUC.0311	Tibial Insert Trial UC #03 T11	1	
KA.IUC.0312	Tibial Insert Trial UC #03 T12	1	
KA.IUC.0313	Tibial Insert Trial UC #03 T13	1	
KA.IUC.0314	Tibial Insert Trial UC #03 T14	1	
KA.IUC.0316	Tibial Insert Trial UC #03 T16	1	
KA.IUC.0318	Tibial Insert Trial UC #03 T18	1	
KA.IUC.0320	Tibial Insert Trial UC #03 T20*	1	
KA.IUC.0409	Tibial Insert Trial UC #04 T09	1	
KA.IUC.0410	Tibial Insert Trial UC #04 T10	1	
KA.IUC.0411	Tibial Insert Trial UC #04 T11	1	
KA.IUC.0412	Tibial Insert Trial UC #04 T12	1	
KA.IUC.0413	Tibial Insert Trial UC #04 T13	1	
KA.IUC.0414	Tibial Insert Trial UC #04 T14	1	
KA.IUC.0416	Tibial Insert Trial UC #04 T16	1	
KA.IUC.0418	Tibial Insert Trial UC #04 T18	1	
KA.IUC.0420	Tibial Insert Trial UC #04 T20*	1	
KA.IUC.0509	Tibial Insert Trial UC #05 T09	1	
KA.IUC.0510	Tibial Insert Trial UC #05 T10	1	
KA.IUC.0511	Tibial Insert Trial UC #05 T11	1	
KA.IUC.0512	Tibial Insert Trial UC #05 T12	1	
KA.IUC.0513	Tibial Insert Trial UC #05 T13	1	
KA.IUC.0514	Tibial Insert Trial UC #05 T14	1	
KA.IUC.0516	Tibial Insert Trial UC #05 T16	1	
KA.IUC.0518	Tibial Insert Trial UC #05 T18	1	
KA.IUC.0520	Tibial Insert Trial UC #05 T20*	1	
KA.IUC.0609	Tibial Insert Trial UC #06 T09	1	
KA.IUC.0610	Tibial Insert Trial UC #06 T10	1	
KA.IUC.0611	Tibial Insert Trial UC #06 T11	1	
KA.IUC.0612	Tibial Insert Trial UC #06 T12	1	
KA.IUC.0613	Tibial Insert Trial UC #06 T13	1	
KA.IUC.0614	Tibial Insert Trial UC #06 T14	1	
KA.IUC.0616	Tibial Insert Trial UC #06 T16	1	
KA.IUC.0618	Tibial Insert Trial UC #06 T18	1	
KA.IUC.0620	Tibial Insert Trial UC #06 T20*	1	
KA.IUC.0709	Tibial Insert Trial UC #07 T09	1	
KA.IUC.0710	Tibial Insert Trial UC #07 T10	1	
KA.IUC.0711	Tibial Insert Trial UC #07 T11	1	
KA.IUC.0712	Tibial Insert Trial UC #07 T12	1	
KA.IUC.0713	Tibial Insert Trial UC #07 T13	1	
KA.IUC.0714	Tibial Insert Trial UC #07 T14	1	

\*Special Order

Part No .	Description	Quantity	Tray
KA.IUC.0716	Tibial Insert Trial UC #07 T16	1	KC.CTT.E0UC
KA.IUC.0718	Tibial Insert Trial UC #07 T18	1	
KA.IUC.0720	Tibial Insert Trial UC #07 T20*	1	
KA.IUC.0809	Tibial Insert Trial UC #08 T09	1	
KA.IUC.0810	Tibial Insert Trial UC #08 T10	1	
KA.IUC.0811	Tibial Insert Trial UC #08 T11	1	
KA.IUC.0812	Tibial Insert Trial UC #08 T12	1	
KA.IUC.0813	Tibial Insert Trial UC #08 T13	1	
KA.IUC.0814	Tibial Insert Trial UC #08 T14	1	
KA.IUC.0816	Tibial Insert Trial UC #08 T16	1	
KA.IUC.0818	Tibial Insert Trial UC #08 T18	1	
KA.IUC.0820	Tibial Insert Trial UC #08 T20*	1	
KA.IUC.0909	Tibial Insert Trial UC #09 T09	1	
KA.IUC.0910	Tibial Insert Trial UC #09 T10	1	
KA.IUC.0911	Tibial Insert Trial UC #09 T11	1	
KA.IUC.0912	Tibial Insert Trial UC #09 T12	1	
KA.IUC.0913	Tibial Insert Trial UC #09 T13	1	
KA.IUC.0914	Tibial Insert Trial UC #09 T14	1	
KA.IUC.0916	Tibial Insert Trial UC #09 T16	1	
KA.IUC.0918	Tibial Insert Trial UC #09 T18	1	
KA.IUC.0920	Tibial Insert Trial UC #09 T20*	1	
KA.IUC.1009	Tibial Insert Trial UC #10 T09	1	
KA.IUC.1010	Tibial Insert Trial UC #10 T10	1	
KA.IUC.1011	Tibial Insert Trial UC #10 T11	1	
KA.IUC.1012	Tibial Insert Trial UC #10 T12	1	
KA.IUC.1013	Tibial Insert Trial UC #10 T13	1	
KA.IUC.1014	Tibial Insert Trial UC #10 T14	1	
KA.IUC.1016	Tibial Insert Trial UC #10 T16	1	
KA.IUC.1018	Tibial Insert Trial UC #10 T18	1	
KA.IUC.1020	Tibial Insert Trial UC #10 T20*	1	
KA.IUC.1109	Tibial Insert Trial UC #11 T09	1	
KA.IUC.1110	Tibial Insert Trial UC #11 T10	1	
KA.IUC.1111	Tibial Insert Trial UC #11 T11	1	
KA.IUC.1112	Tibial Insert Trial UC #11 T12	1	
KA.IUC.1113	Tibial Insert Trial UC #11 T13	1	
KA.IUC.1114	Tibial Insert Trial UC #11 T14	1	
KA.IUC.1116	Tibial Insert Trial UC #11 T16	1	
KA.IUC.1118	Tibial Insert Trial UC #11 T18	1	
KA.IUC.1120	Tibial Insert Trial UC #11 T20*	1	